

WARNING: DISCONNECT POWER AT THE MAIN FUSE BOX BEFORE INSTALLATION.

WARNING:

This fixture is intended for installation in accordance with the National Electrical Code (NEC) and all local code specifications. If you are not familiar with code requirements, installation by a certified electrician is recommended.

Before assembly, remove all parts and part packages from box. If anything is missing, please contact the retailer from which the product was purchased.

elk HOME

ANY QUESTIONS CALL: 800-613-3261
M-F 8:00AM-6:00PM ET

ITEM#: 14534/1

1. Carefully pull house wires out of junction box so they are easily accessible during installation.
2. Position mounting bracket (A) so threaded ends of attached fixture mounting screws (E) are facing down towards floor.
3. Carefully pull house wires through center hole in mounting bracket (A).
4. Align small holes in mounting bracket (A) with holes in junction box. Thread each junction box screw (B) into appropriate hole in mounting bracket (A) and into hole in junction box. Tighten junction box screws (B) to secure mounting bracket (A) to junction box. **CAUTION:** Make sure house wires are pulled completely through hole in mounting bracket. **DO NOT** pinch wires between mounting bracket and ceiling.

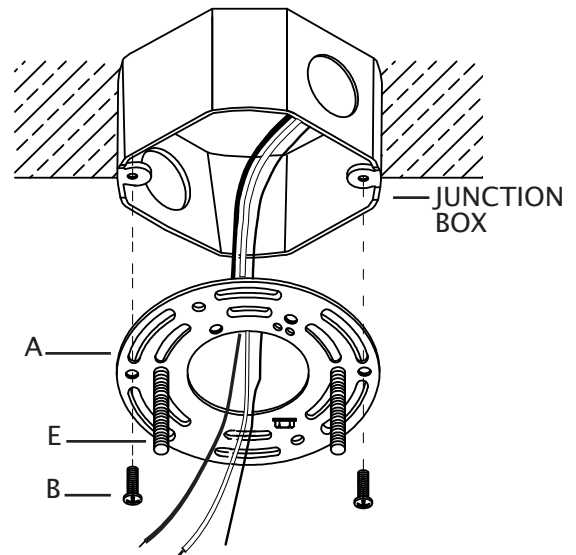

5. Attach one locking link (G) to loop on top of fixture body (O).
6. Determine desired hanging height of fixture. Cut chain (H) to length to achieve desired height.
7. Slip chain link at end of chain (H) onto locking link (G) on loop on top of fixture body (O).
8. Slip second locking link (G) onto other end of chain. Attach second locking link (G) to loop on canopy (D).
9. Weave fixture wires from top of fixture body (O) through chain links, skipping every other chain link.
10. Carefully push fixture wires up through hole in center of canopy (D). Pull fixture wires taut.

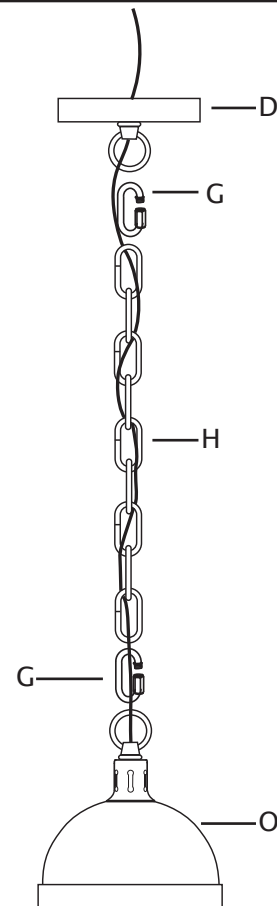

11. Strip 3/4" of insulation from ends of fixture wires.
12. Slightly loosen ground screw on mounting bracket (A). Do not completely remove ground screw. Wrap house ground wire (copper) around ground screw, leaving enough ground wire to attach to fixture ground wire. Twist end of fixture ground wire and end of house ground wire together. Twist wire nut (C) onto ends of wires. Completely tighten wire nut (C). Reference chart below for correct wire connections.

Connect Supply (House) Ground Copper Wire to:
Bare Copper Wire or,
Bare Silver Wire or,
Green Insulated Wire.

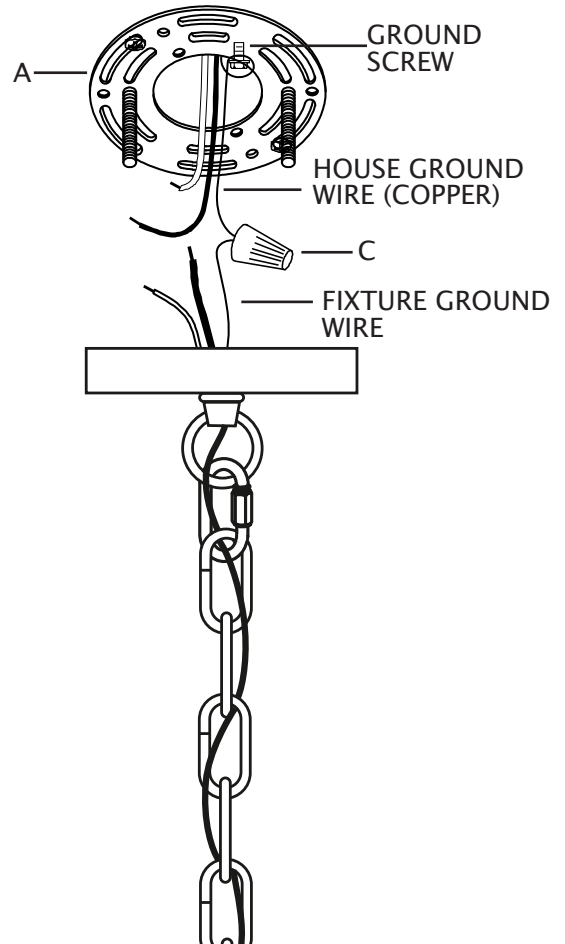

13. Twist end of house lead wire (black) and end of fixture lead wire together. Twist wire nut (C) onto ends of wires. Completely tighten wire nut (C). Twist end of house neutral wire (white) and end of fixture neutral wire together. Twist wire nut (C) onto ends of wires. Completely tighten wire nut (C). Reference chart to the right for correct wire connections.
14. Wrap electrical tape (not included) around wire nuts (C) and wires. Ensure wires are securely fastened into wire nuts.
15. Carefully push all wires and wire nuts into junction box.

Connect Black Lead Supply (House) Wire to:	Connect White Neutral Supply (House) Wire to:
Black Wire or,	White Wire or,
*Parallel Cord (Round and Smooth) or,	*Parallel Cord (Square and Ridged) or,
No printed words on wire insulation or,	Printed words on wire insulation or,
Insulated Wire (other than green) with Copper Conductor.	Insulated Wire (other than green) with Silver Conductor.

*When parallel wire (SPT 1 & SPT 2) is used:
The lead wire is round in shape or smooth.
The neutral wire is square in shape or ridged.

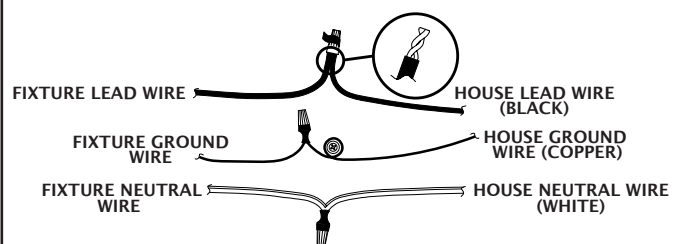

16. Carefully raise fixture up to ceiling. Place canopy (D) of fixture over mounting bracket (A). Pass holes in canopy (D) over ends of fixture mounting screws (E).
17. Screw one threaded cap (F) onto end of one fixture mounting screw (E).
18. Screw second threaded cap (F) onto end of second fixture mounting screw (E). Tighten both threaded caps (F) to secure fixture to ceiling. DO NOT over tighten.
19. Screw recommended bulb (E26 Edison bulb type, not included) into socket. Verify correct bulb wattage marked on socket of fixture.
WARNING: DO NOT exceed maximum bulb wattage.
20. Raise glass shade (K) up to fixture. Fit top of glass shade (K) inside fixture body (O).
21. Thread one thumbscrew (L) into each hole along edge of fixture body (O). Equally tighten each thumbscrew (L) to secure glass shade (K) in place. DO NOT over tighten.

